

NESTiG

The Starship Shelf

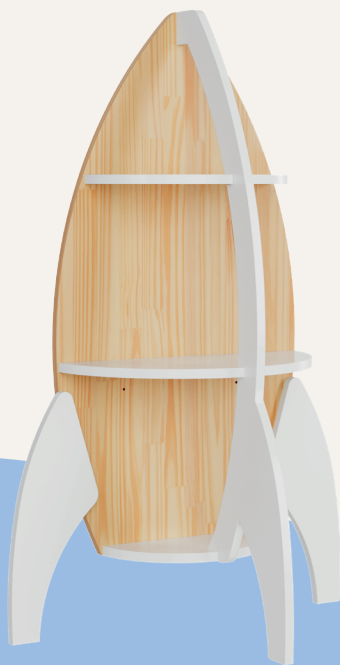

Please read all instructions before assembly
and use of product!

Lisez toutes les instructions avant
d'assembler et d'utiliser le produit!

Welcome to the Nestig World!

Our Warranty

Our products come with a limited two year warranty! We do our best to ensure everything arrives in perfect shape, but if anything arrives damaged, missing, or defective, our Customer Experience team is here to help.

Just email us at hello@nestig.com and we'll be glad to assist!

For more information on our warranty, visit:

<https://www.nestig.com/pages/warranty-policy>

Bienvenue dans le monde de Nestig!

Notre Garantie

Nos produits sont accompagnés d'une garantie limitée de deux ans! Nous faisons de notre mieux pour que tout arrive forme parfaite, mais si quelque chose arrive endommagé, manquant ou défectueux, notre équipe Expérience Client est là pour vous aider.

Envoyez-nous un e-mail à hello@nestig.com et nous serons heureux de vous aider!

Pour plus d'informations sur notre garantie, visitez:

<https://www.nestig.com/pages/warranty-policy>

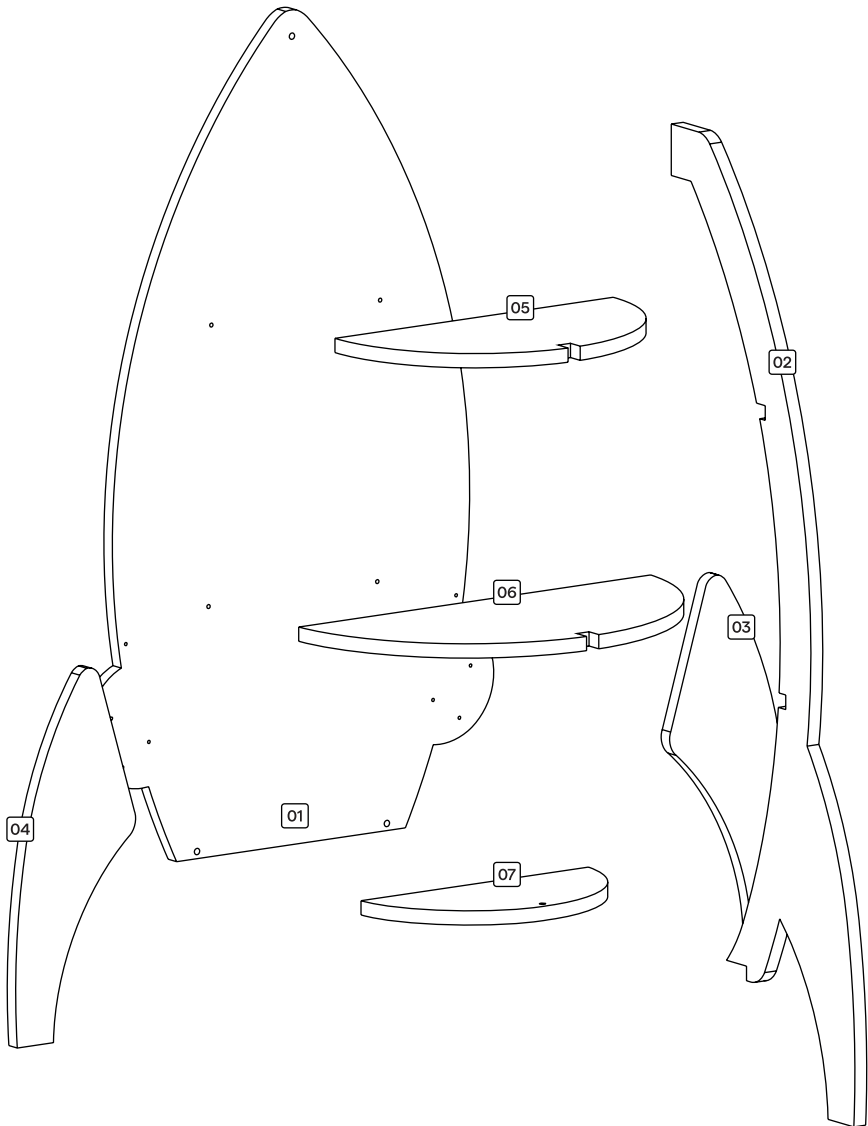

Item	Description	Quantity
01	Back Panel	01
02	Front Leg	01
03	Right Lateral Leg	01
04	Left Lateral Leg	01
05	Top Shelf	01
06	Middle Shelf	01
07	Bottom Shelf	01

Not included: Phillips head screwdriver and hammer



Phillips head screwdriver

How to use the cam lock nut and bolt

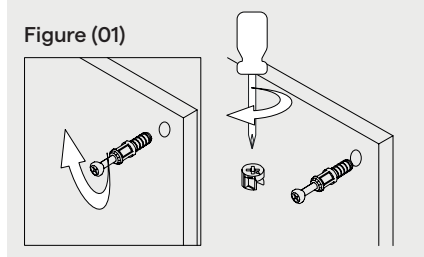

Hardware list

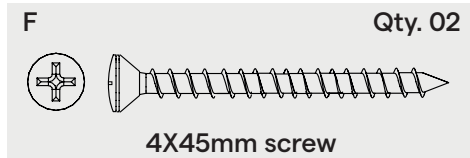
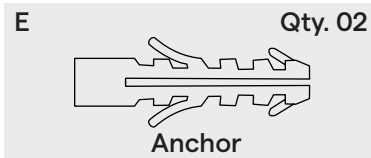
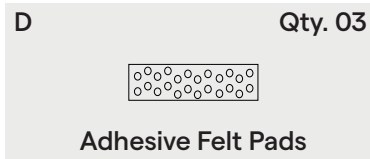
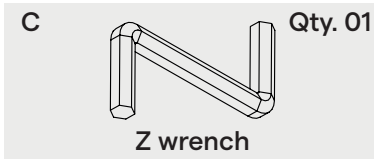
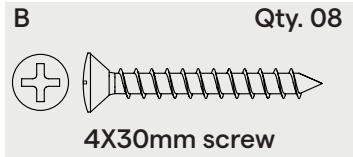
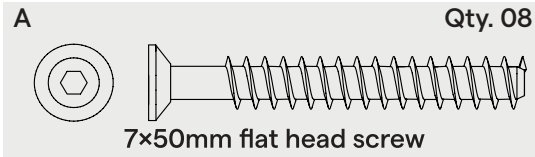

STEP 1 01 03 04

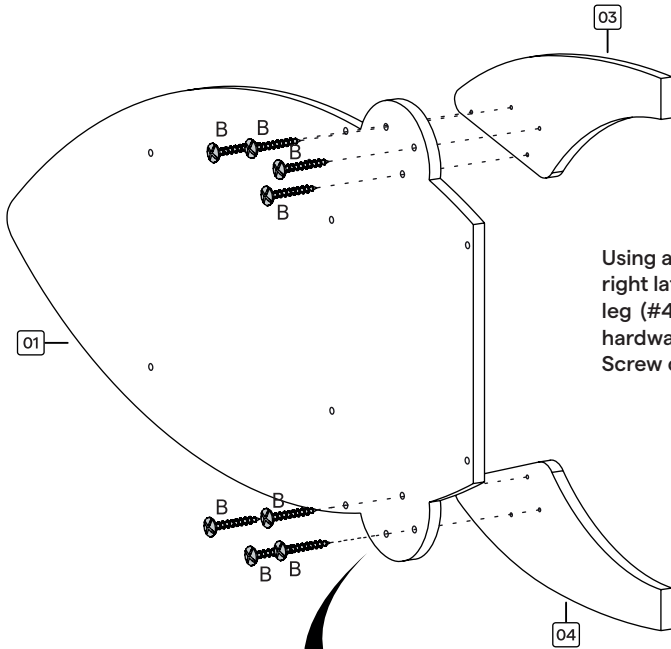
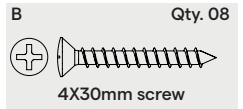

Using a Phillips screwdriver, attach the right lateral leg (#3) and the left lateral leg (#4) to the back panel (#1) using hardware "B" as shown in the image. Screw clockwise until tightened.

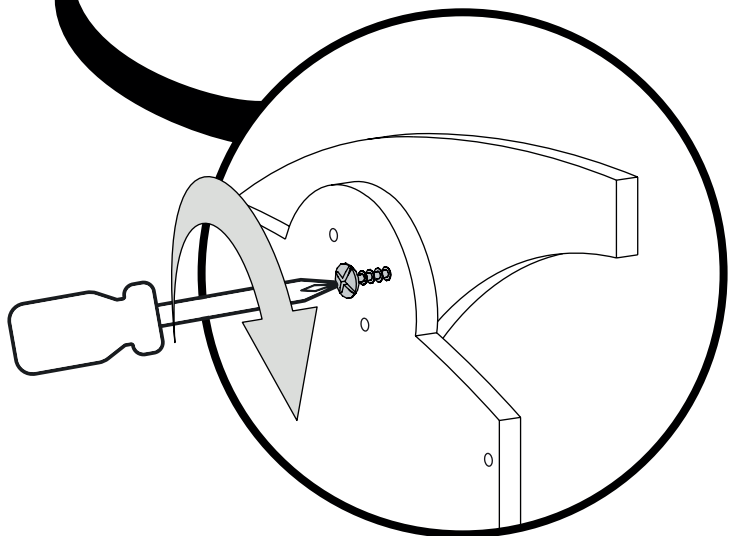

STEP 2

05 06 07

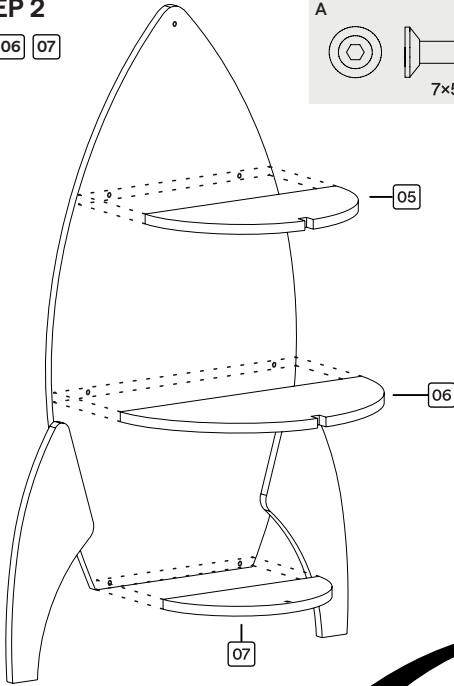
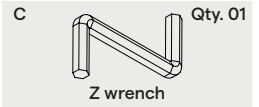
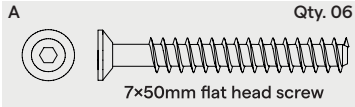

Position the structure upright. With the help of another person, attach the top shelf (#5), middle shelf (#6) and bottom shelf (#7) to the back panel (#1) using the Z wrench "C" and hardware "A".

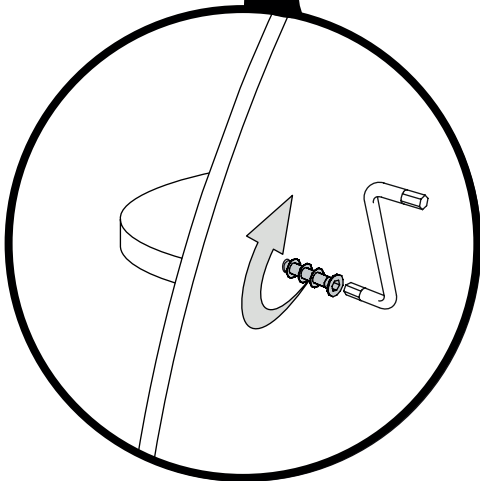
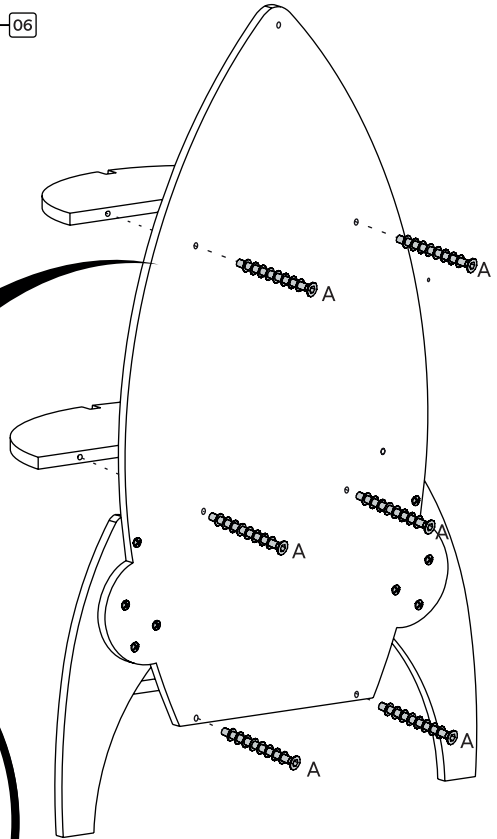

Screw in clockwise until tightened using Z wrench "C".

STEP 3 02

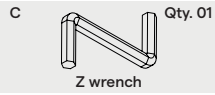
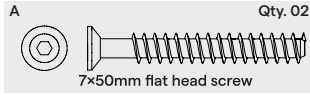

With the help of another person, position the front leg (#2) upright and glide it into the spaces in the top (#5), middle (#6) and bottom (#7) shelves. Then, secure the top of the front leg (#2) to the back panel (#1) using hardware "A" and the Z wrench "C". Turn clockwise until tightened.

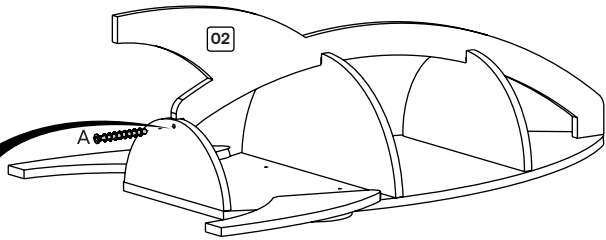
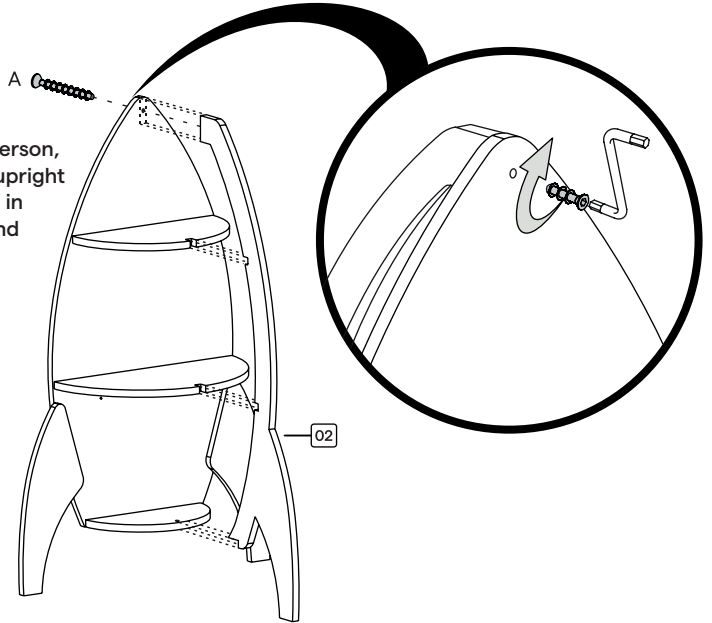

Place the shelves face down on a clean surface. Secure the bottom of the front leg (#2) to the bottom shelf (#7) using hardware "A" and the Z wrench "C". Turn clockwise until tightened.

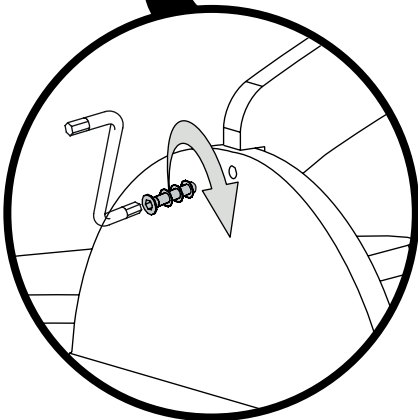

STEP 4

D

Qty. 03



Adhesive Felt Pads

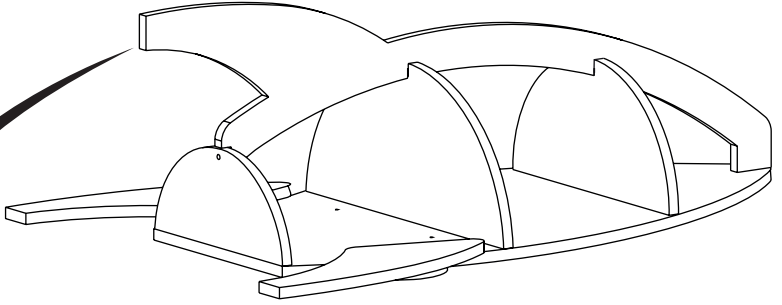

Attach the adhesive felt pads "D" to the bottom of each leg.

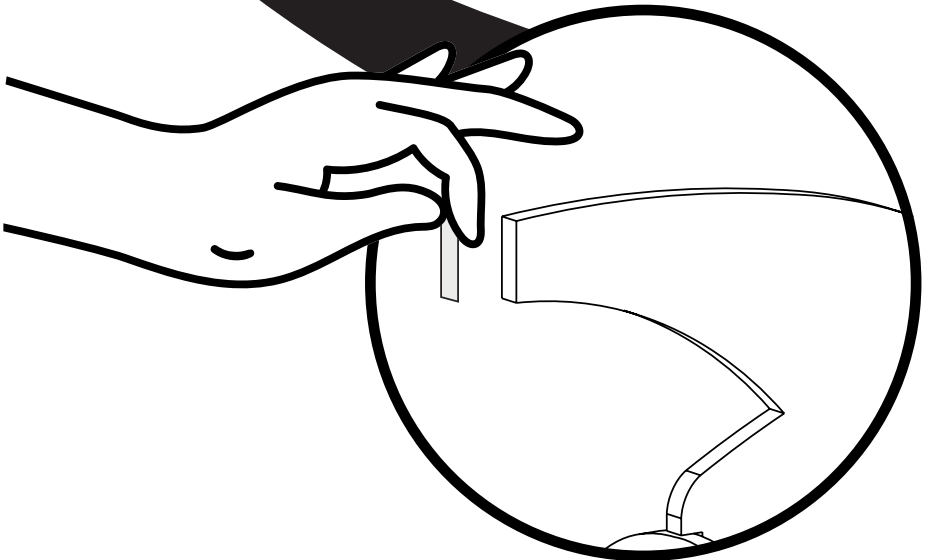

STEP 5

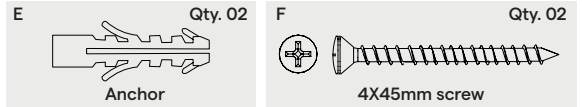

With the help of another person, position the shelf in the desired location and mark the wall where the holes on either side of the furniture line up. Use a drill to create holes in the wall corresponding to the holes in the furniture. Insert the anchor pieces "E" into the holes in the wall. Then attach the furniture to the wall, threading the "F" screws into each anchor "E" and turning clockwise with a Phillips screwdriver until tightened.

WARNING: To ensure the utmost safety, this shelf must be attached to a wall using the included hardware

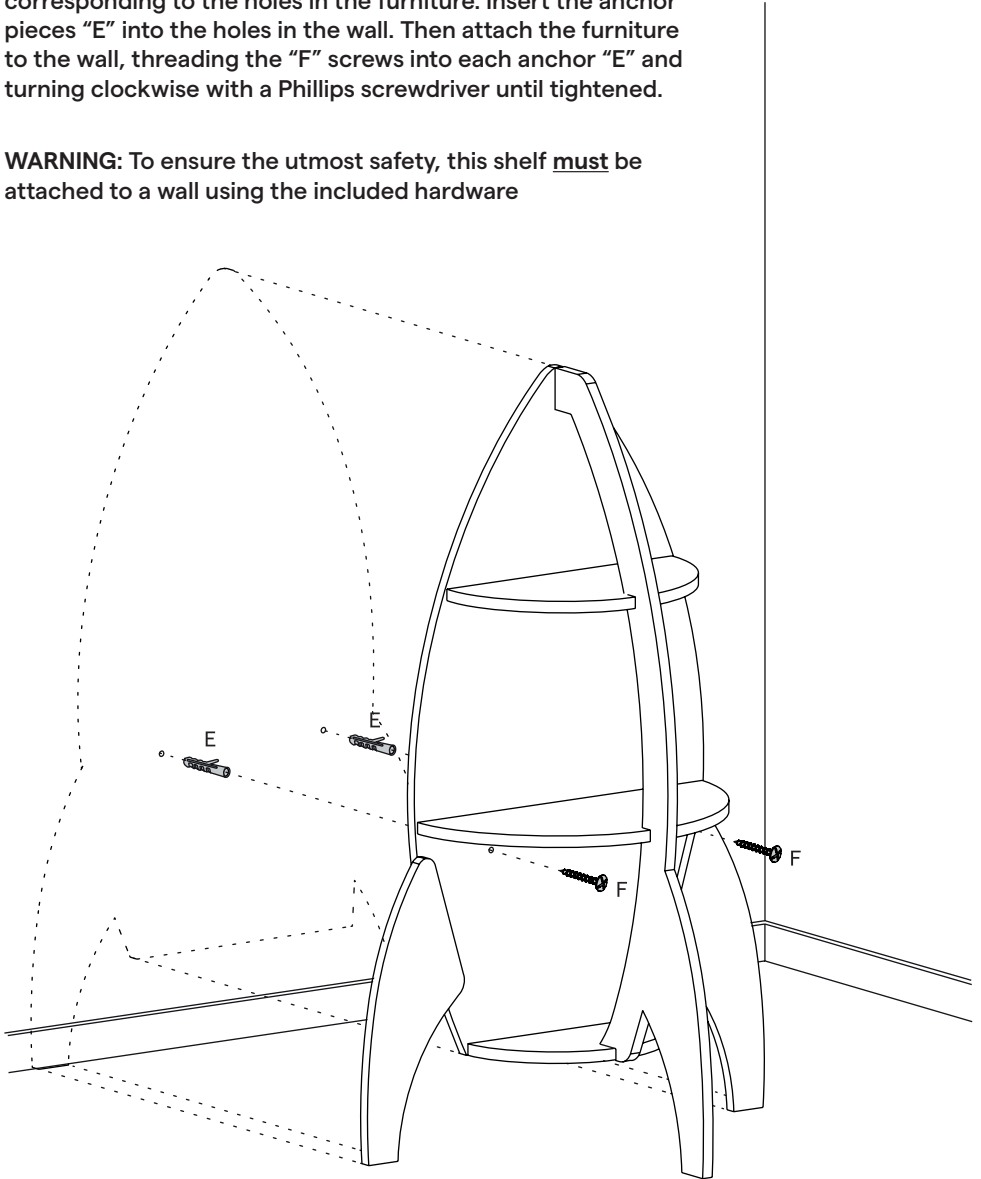

We're Here to Help!

Our product specialists are on hand to answer any questions, help you set up and use your Nestig products, and bring the nursery you imagine to life:

Email us at hello@nestig.com
www.nestig.com/support
Monday - Friday | 10am-5pm ET

Nous sommes là pour vous aider!

Nos spécialistes produits sont à votre disposition pour répondre à toutes vos questions, vous aider à installer et utiliser vos produits Nestig et donner vie à la chambre d'enfant que vous imaginez:

Contactez-nous au hello@nestig.com
www.nestig.com/support
Lundi - Vendredi | 10h-17h HE



nestig.com



Nestig, Inc.
hello@nestig.com
PO Box 1106, New York, NY 10023